

INSTALLATION INSTRUCTIONS

N1580 / N1590

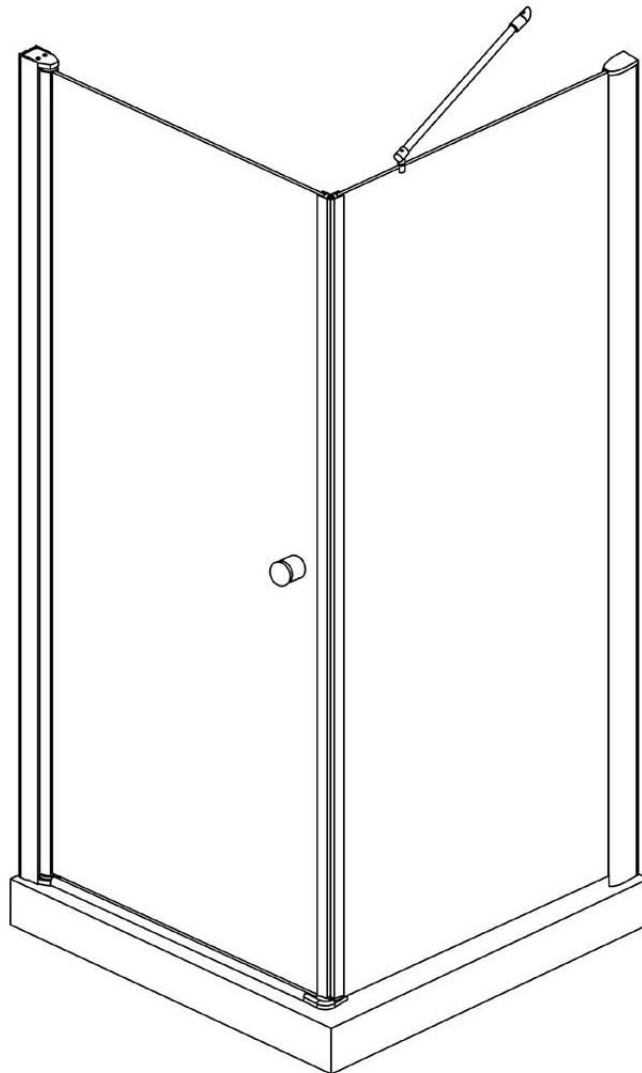

Size: 800x800x1950mm
900x900x1950mm



Sanotechnik
Handelsgesellschaft m.b.H.
Industriestraße 5
A-2752 Wöllersdorf
Tel.: 0043/2622/421 93-0
Fax. 0043/2622/421 93-6
Email: office@sanotechnik.at
www.sanotechnik.com



Sanotechnik RUMĂNIEN S.R.L
ROMANIA
Tancabesti, DN 1, KM 26,5
Com. Snagov, jud. Ilfov
Tel.: +40 21 350 13 43
Fax: +40 21 350 13 44
office@sanotechnik.ro
www.sanotechnik.com



SANOTECHNIK d.o.o
SLOVENIA
Stritarjeva ulica 24
SI-2000 Maribor
Tel.: +386 2/421 33 50
Fax: +386 2/421 33 58
info@sanotechnik.si
www.sanotechnik.com



SANOTECHNIK Hungária Kft.
HUNGARY
Nagyfőtényi út 112
H-1222 Budapest
Tel.: +36 1/424 06 70
Fax: +36 1/424 06 79
info@sanotechnik.hu
www.sanotechnik.com



SANOTECHNIK Maurod s.r.o.
SLOWAKIA+CZECHIA
Sládkovičova 69
SK-953 01 Zlaté Moravce
Tel.: +421/376 426 245
Fax : +421/376 426 246
maurod@maurod.sk
www.sanotechnik.com



FORMATIC Ltd.
BULGARIA
3, Georgi Benev St.
BG-4003 Plovdiv
P.O. BOX 85
Tel.: +359 32/9611 01
Fax: +359 32/9611 02
dimana.pappas@mail.com

General Information

Please inspect the product immediately upon receipt for transit damage, missing packs/parts or manufacturing fault. Damage reported later cannot be accepted. Please handle the product with care avoiding knocks and shock loading to all sides and edges of the glass

Notes : Safety glass can not be re-worked.

Please read these instructions carefully before start of installation.

Special care should be taken when drilling walls to avoid hidden pipes or electrical cables.

Note : this product is heavy and may require two people to install.

Aftercare instructions

After use, your shower should be cleaned with soap and water. This is particularly important in hard water districts where insoluble lime salts may be deposited and allowed to build up.

Cleaners of gritty or abrasive nature should be used. Care should be taken to avoid contact with strong chemicals such as organic solvents and strippers.

Glass cleaners can be used but with caution, if in doubt contact the manufacturer of the cleaner in question.

Please keep these instructions for aftercare and customer services details.



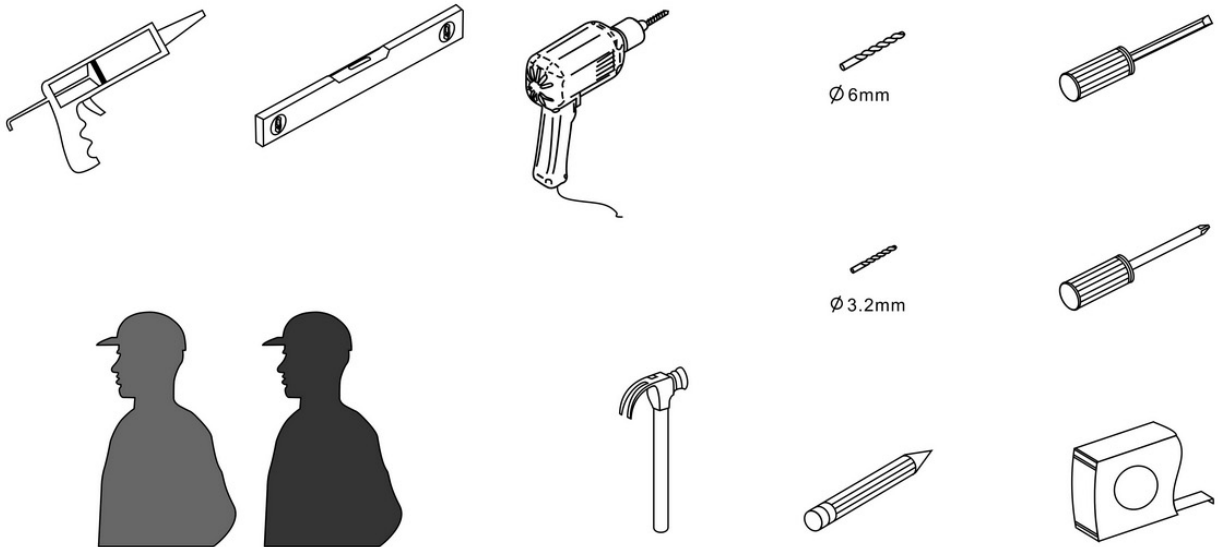





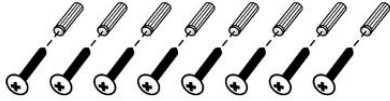
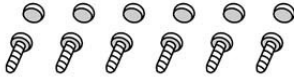

Tools required

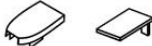

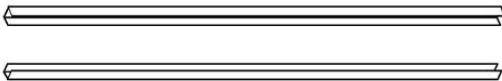
This product is heavy and may require two people to install.

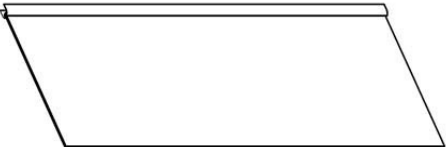
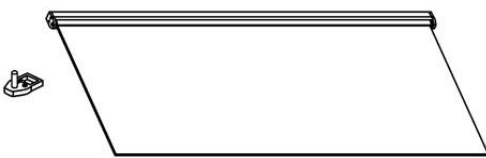

◆ **Box contents**

<p>(1) Installation instruction</p>	<p>➔</p>	
<p>(2) 8 x wall plugs 8 x flat screw M4x35</p>	<p>➔</p>	
<p>(3) 6 x screws M4x8 6 x screw cover caps</p>	<p>➔</p>	
<p>(4) 1 x handle set</p>	<p>➔</p>	
<p>(5) 2 x profile cover</p>	<p>➔</p>	
<p>(6) 1 x bracket 1 x glass connect clip 1 x wall connect clip</p>	<p>➔</p>	
<p>(7) 2 x wall posts</p>	<p>➔</p>	 
<p>(8) 2 x magnetic seals</p>	<p>➔</p>	 
<p>(9) 1 x aluminum seals 1 x clip-L 1 x clip-R</p>	<p>➔</p>	 
<p>(10) 1 x wall deflectors</p>	<p>➔</p>	 
<p>(11) 1 x fixed panel</p>	<p>➔</p>	
<p>(12) 1x door panel 1x clip-L</p>	<p>➔</p>	

◆ Assembly drawing

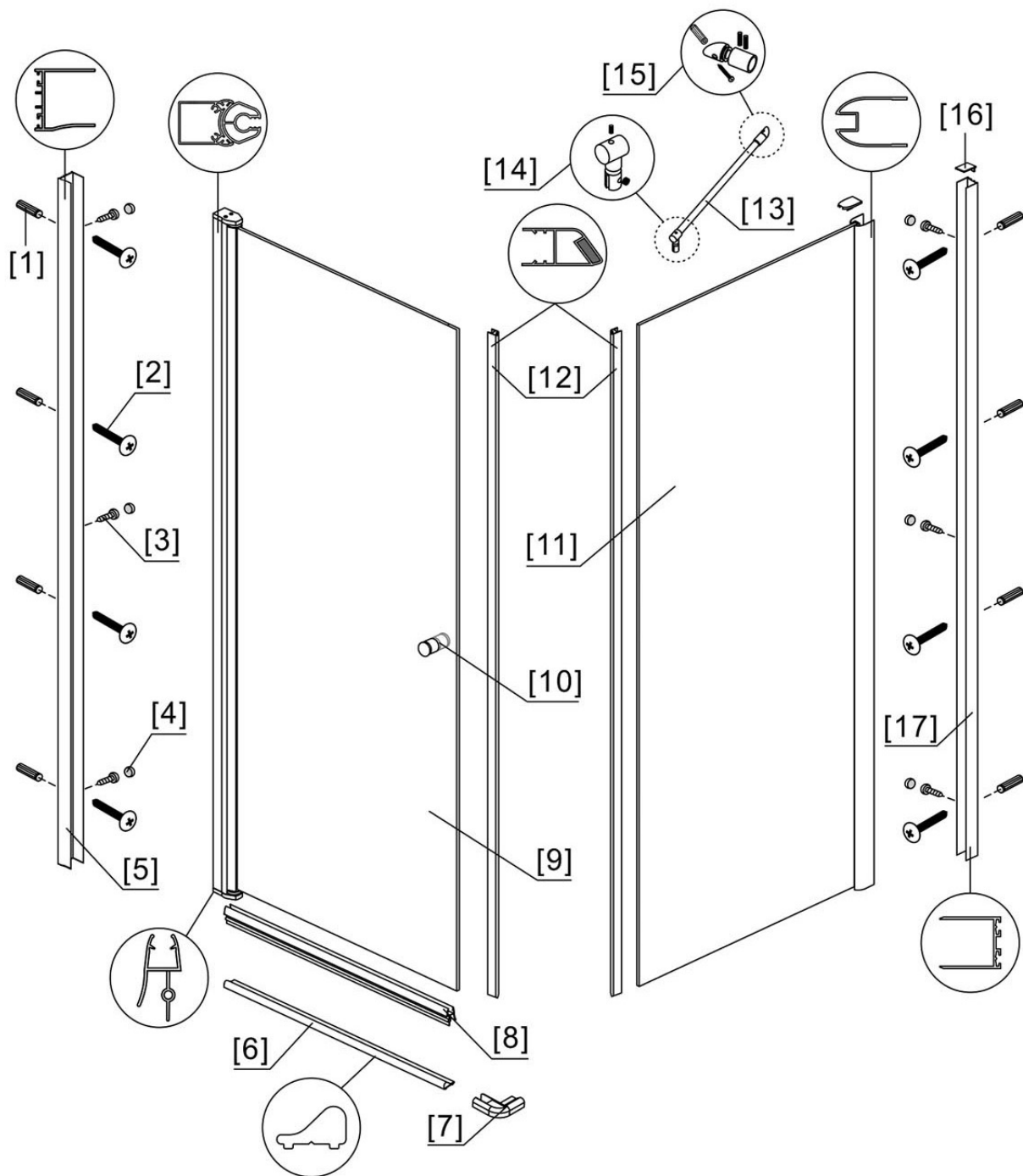

- (1) 8 x wall plugs
- (2) 8 x flat screws M4x35
- (3) 6 x screw M4x8
- (4) 6 x screw cover caps
- (5) 1 x wall post
- (6) 1 x magnetic seal
- (7) 1 x clip
- (8) 1 x water deflector

- (9) 1 x door panel
- (10) 1 x handle set
- (11) 1 x fixed panel
- (12) 2 x magnetic seals
- (13) 1x bracket
- (14) 1 x glass connect clip
- (15) 1 x wall connect clip
- (16) 2 x profile covers

◆ Installation steps

Step 1

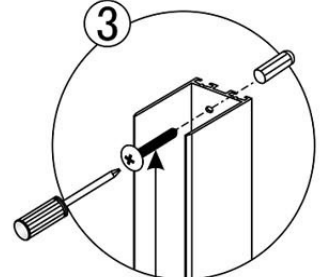
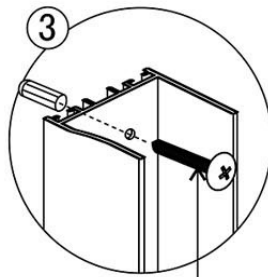
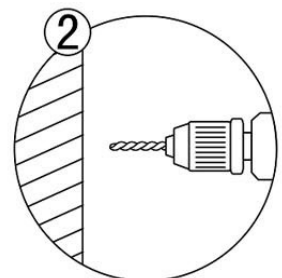
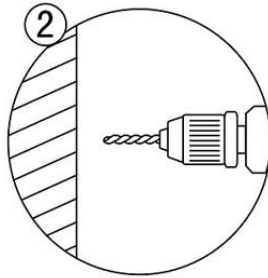
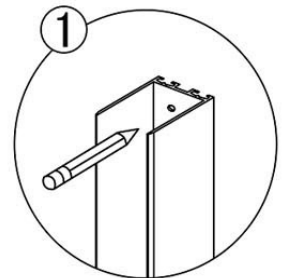
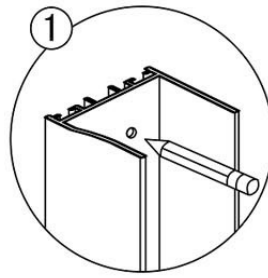
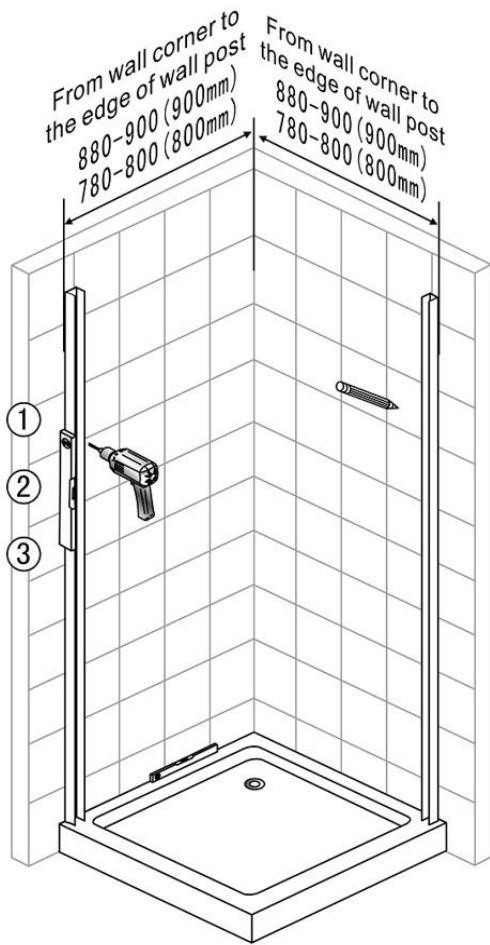

Flat screw M4x35

Flat screw M4x35

Step 2

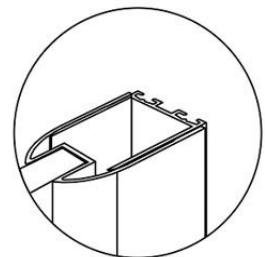
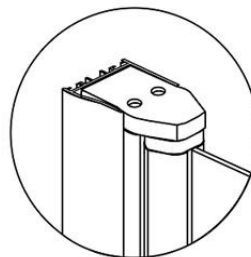
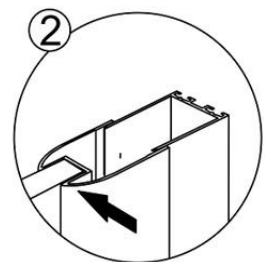
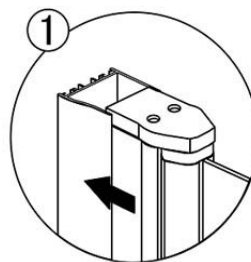
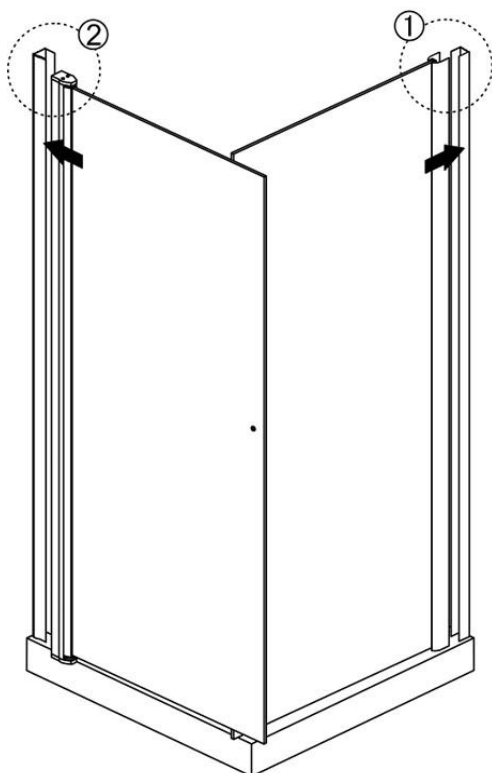

Step 3

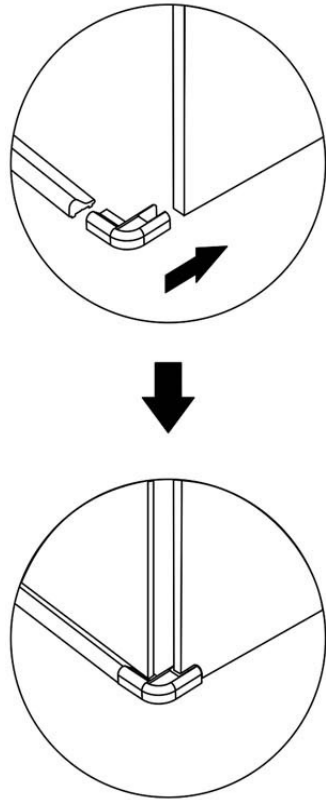
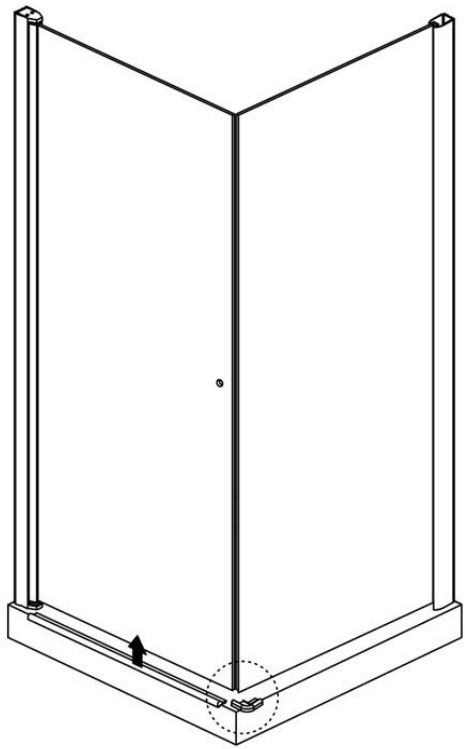

Step 4

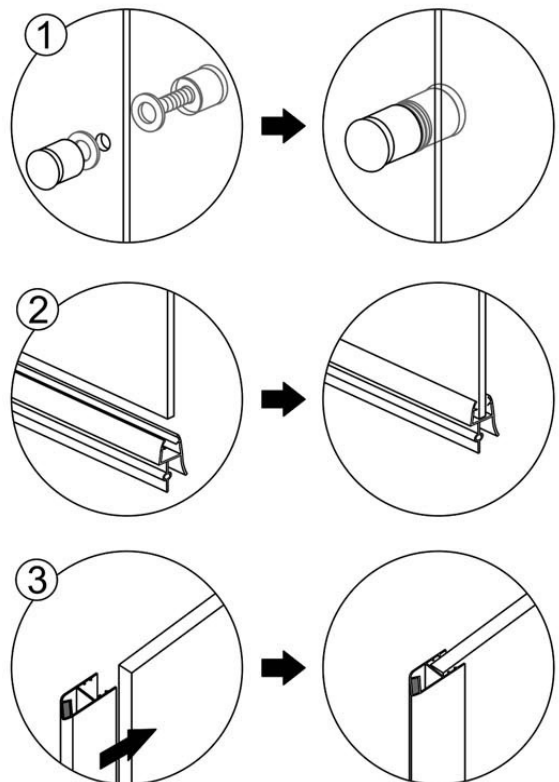
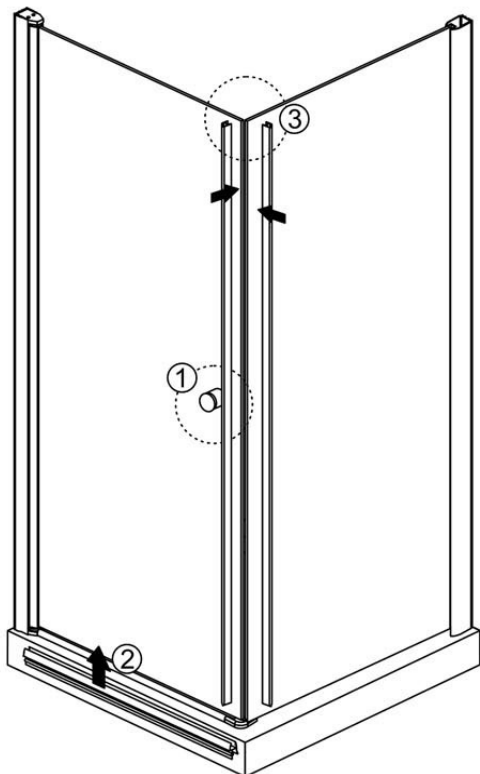

Step 5

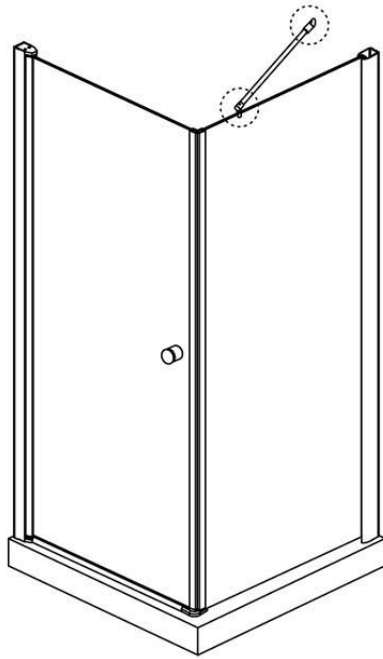

Ensure wall profile are plumb.
Adjust enclosure to be square and level.
Wheels should be adjusted to square the
doors and ensure smooth running.

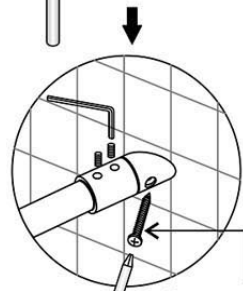
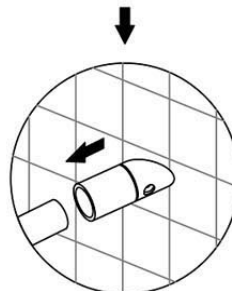
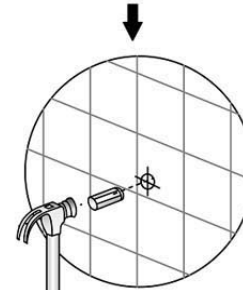
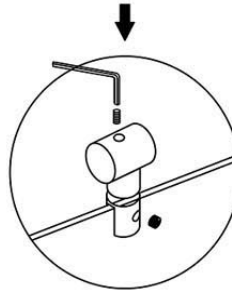
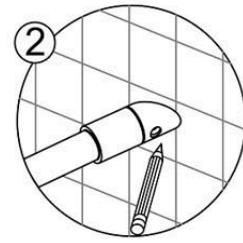
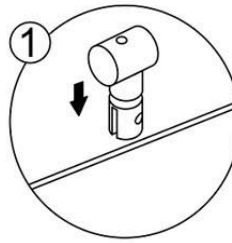

Screw M4x35

Step 6

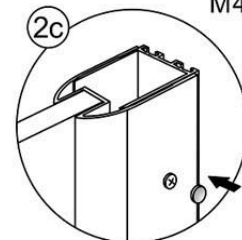
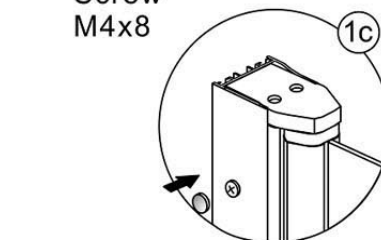
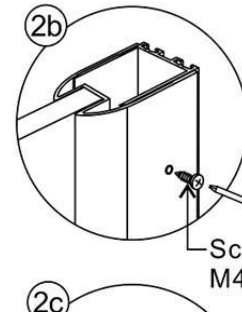
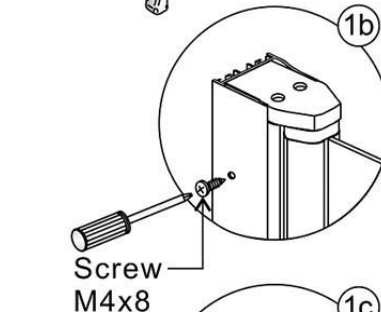
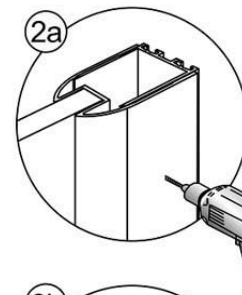
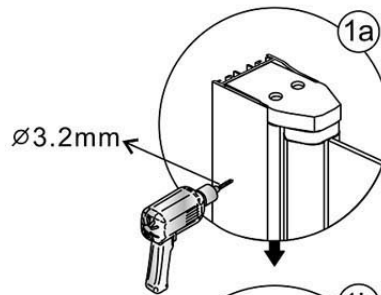
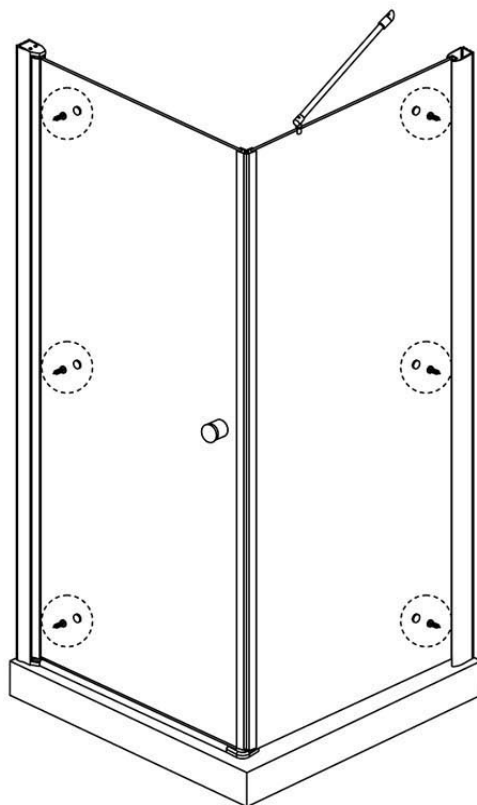

Screw
M4x8

Screw
M4x8

View from inside

Step 7

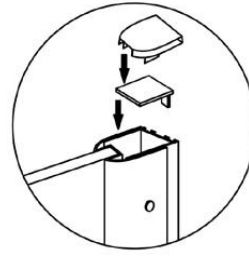
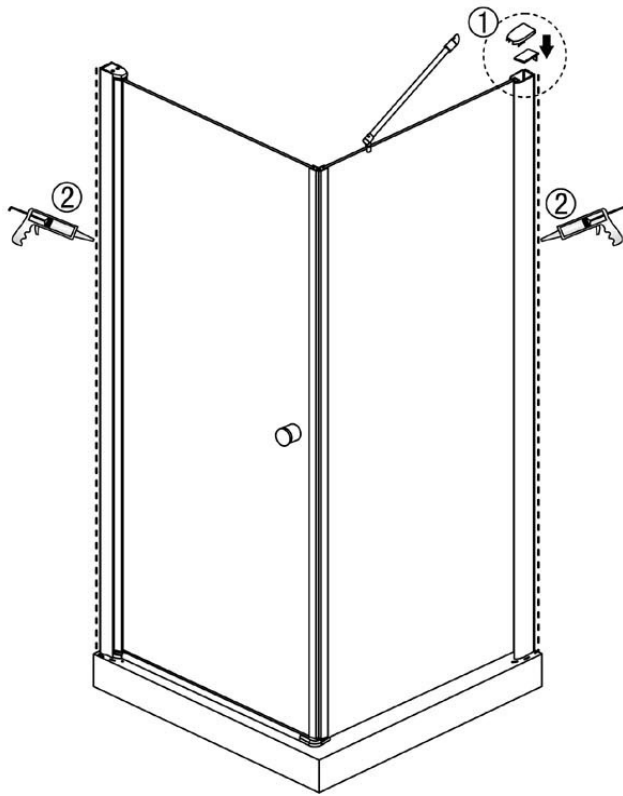

Allow 24 hours for silicone to dry before use.