

- D Montageanleitung  
 E Mounting Instruction  
 HR Uputi za upotrebu  
 SLO Navodlilo za monta o kadi  
 HU Útmutató a zuhanykabin beszereléséhez  
 RO Instrucțiuni de montaj  
 CZ Návod k montá I vany  
 SK Návod na montáž  
 TR Montaj Klavuzu  
 BG Инструкции за монтаж

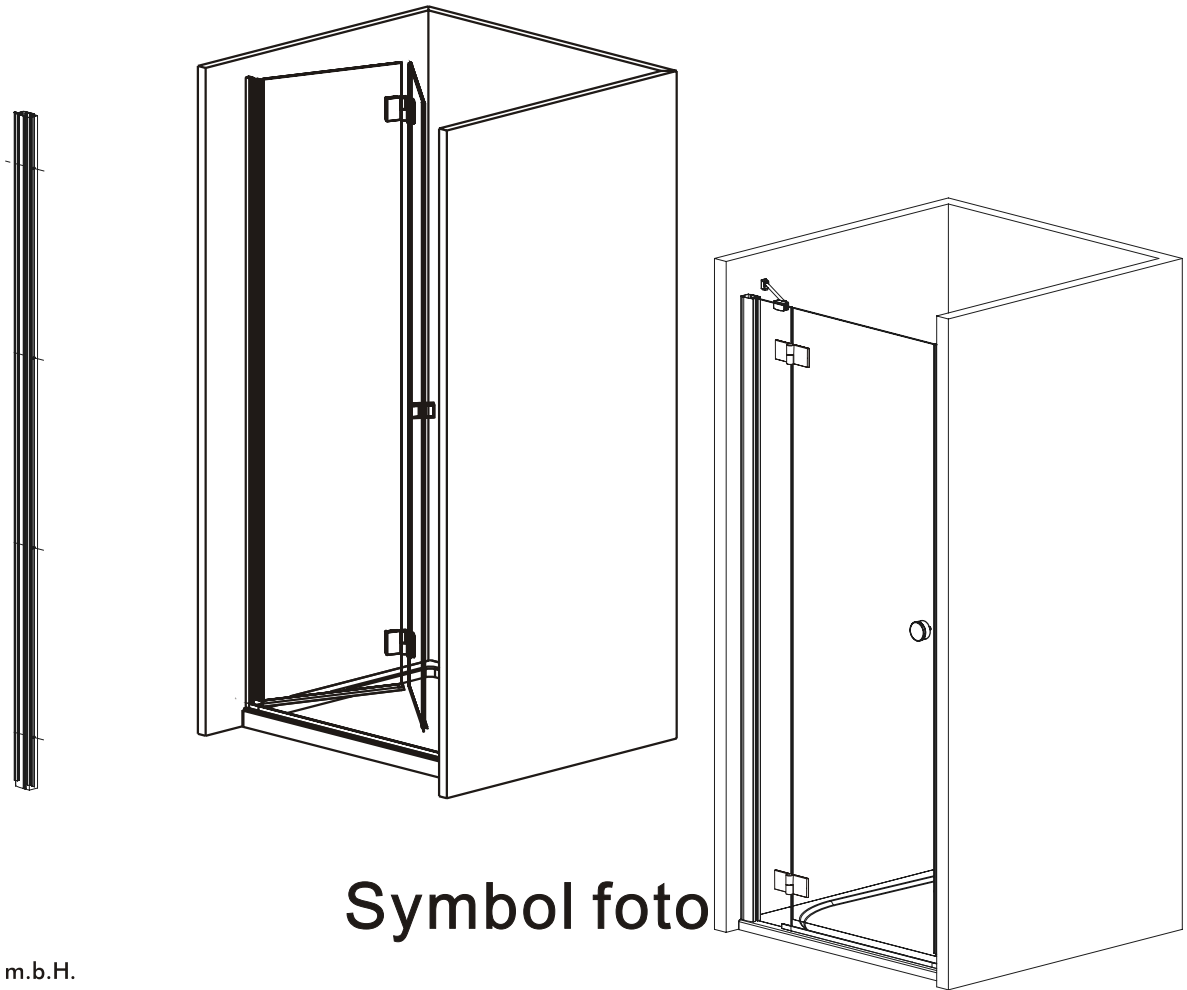

Symbol foto



Sanotechnik  
 Handelsgesellschaft m.b.H.  
 Industriestraße 5  
 A-2752 Wöllersdorf  
 Tel.: 0043/2622/421 93-0  
 Fax. 0043/2622/421 93-6

Email: [office@sanotechnik.at](mailto:office@sanotechnik.at)  
[www.sanotechnik.com](http://www.sanotechnik.com)



Sanotechnik RUMÄNIEN S.R.L  
 ROMANIA  
 Tancabesti, DN 1, KM 26,5  
 Com. Snagov, jud. Ilfov  
 Tel.: +40 21 350 13 43  
 Fax: +40 21 350 13 44

[office@sanotechnik.ro](mailto:office@sanotechnik.ro)  
[www.sanotechnik.com](http://www.sanotechnik.com)



SANOTECHNIK d.o.o  
 SLOVENIA  
 Stritarjeva ulica 24  
 SI-2000 Maribor  
 Tel.: +386 2/421 33 50  
 Fax: +386 2/421 33 58

[info@sanotechnik.si](mailto:info@sanotechnik.si)  
[www.sanotechnik.com](http://www.sanotechnik.com)



SANOTECHNIK Hungária Kft.  
 HUNGARY  
 Nagytétényi út 112  
 H-1222 Budapest  
 Tel.: +36 1/424 06 70  
 Fax: +36 1/424 06 79

[info@sanotechnik.hu](mailto:info@sanotechnik.hu)  
[www.sanotechnik.com](http://www.sanotechnik.com)



SANOTECHNIK Maurod s.r.o.  
 SLOWAKIA+CZECHIA  
 Sládkovičova 69  
 SK-953 01 Zlaté Moravce  
 Tel.: +421/376 426 245  
 Fax: +421/376 426 246

[maurod@maurod.sk](mailto:maurod@maurod.sk)  
[www.sanotechnik.com](http://www.sanotechnik.com)



Sun Banyo  
 TURKEY  
 Bostanci Mag.Bagdat  
 cd.yomca apt.No,504/5  
 KADIKOY/ISTANBUL  
 Tel:+90 216 384 6179  
 Fax:+90 216 384 6180  
[umut@sanotechnik.com.tr](mailto:umut@sanotechnik.com.tr)







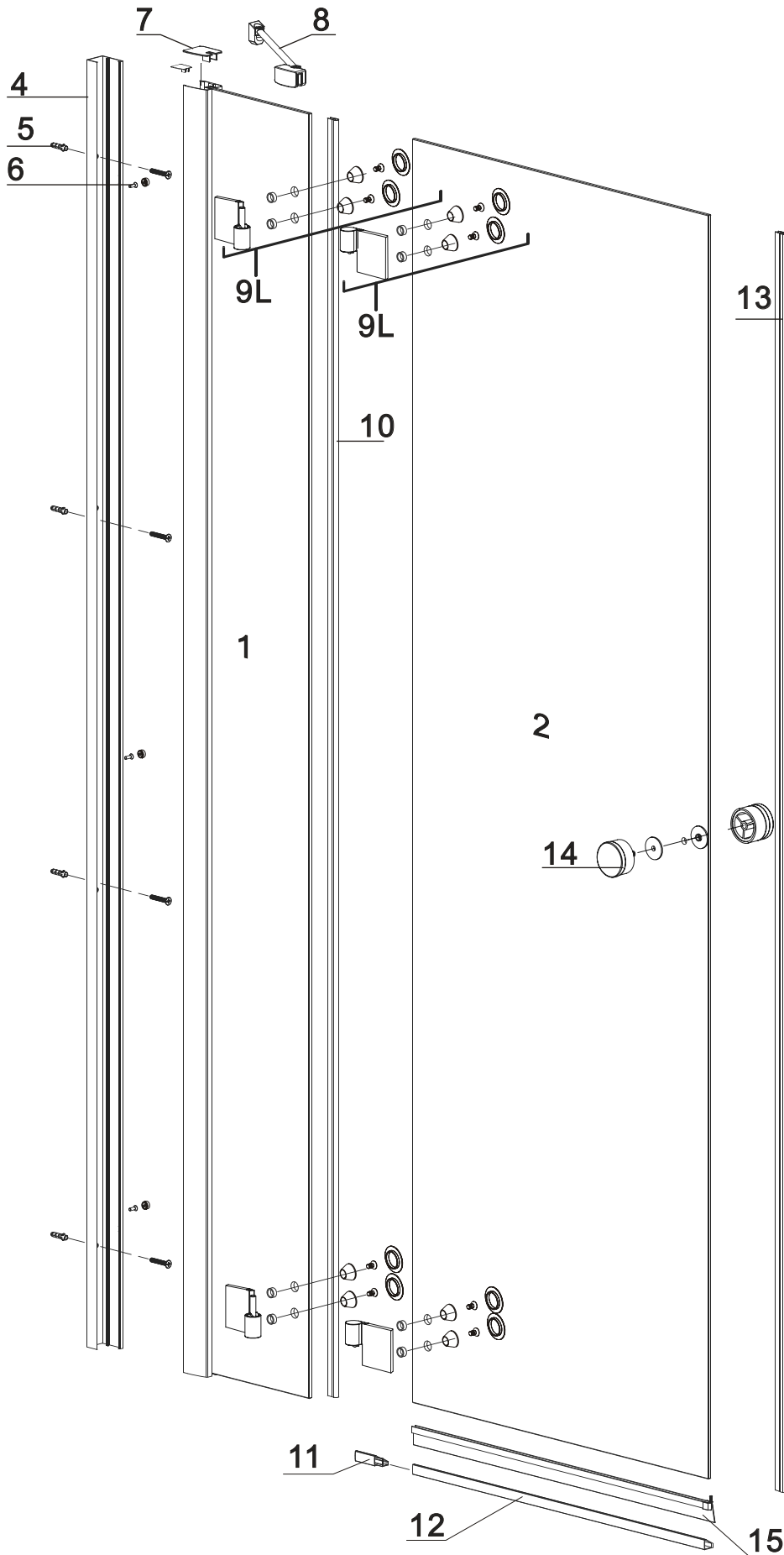



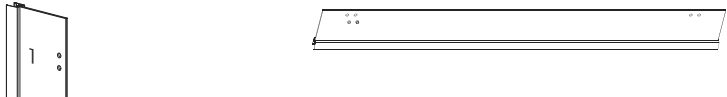
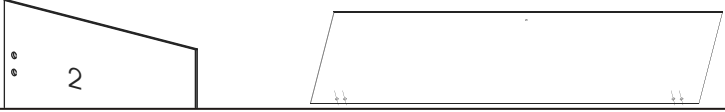
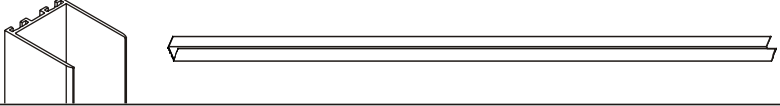
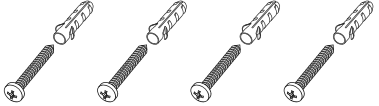

FORMATIC Ltd.  
 BULGARIA  
 3, Georgi Benev St.  
 BG-4003 Plovdiv  
 P.O. BOX 85  
 Tel.: +359 32/9611 01  
 Fax: +359 32/9611 02  
[Office@sanotechnik.bg](mailto:Office@sanotechnik.bg)

## ◆ Assembly Drawing

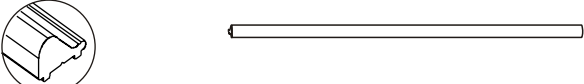





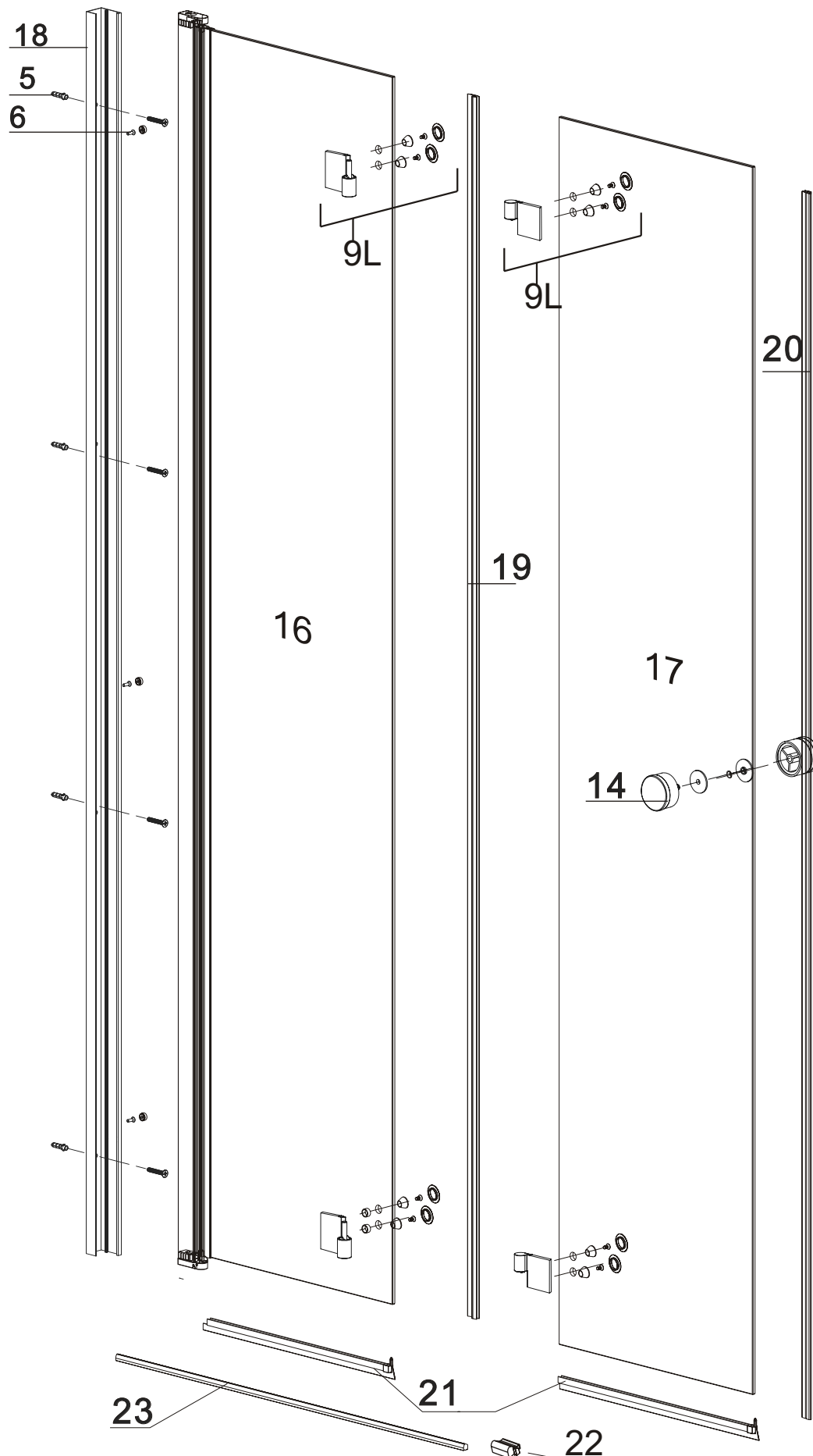

## ◆ Box Contents

1		X1
2		X1
4		X1
5		X4
6		X3
7		X1
8		X1
9L		X2
10		X1
11		X1
12		X1
13		X1
14		X1
15		X1

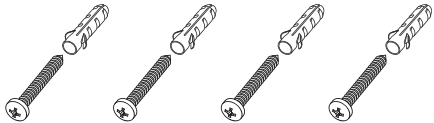
## ◆ Assembly Drawing

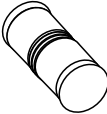
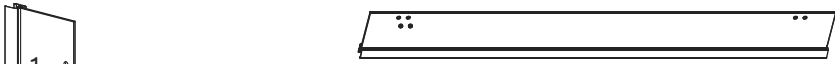
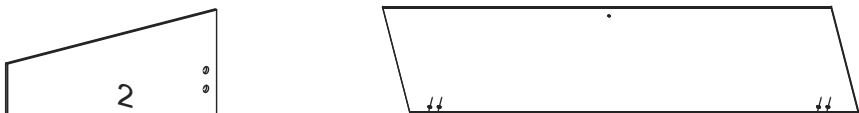
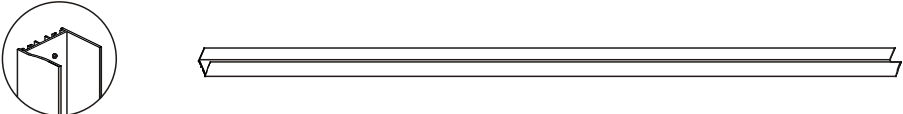

## ◆ Box Contents

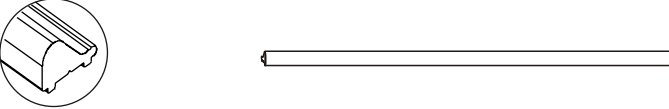
5		X4
6		X3
9L		X2
14		X1
16		X1
17		X1
18		X1
19		X3
20		X1
21		X2
22		X1

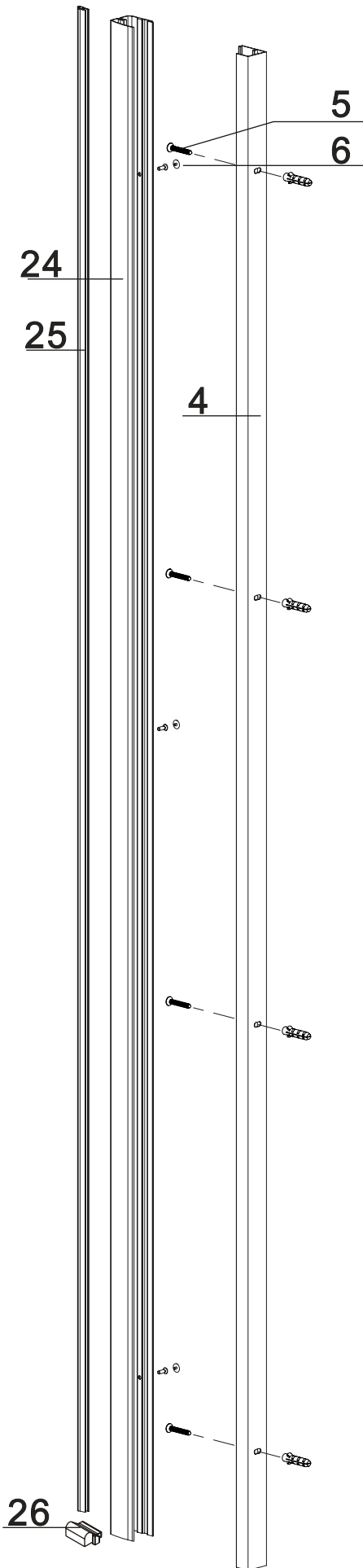

◆ Box Contents

4		X1
5		X4
6		X3
24		X1
25		X1
26		X1

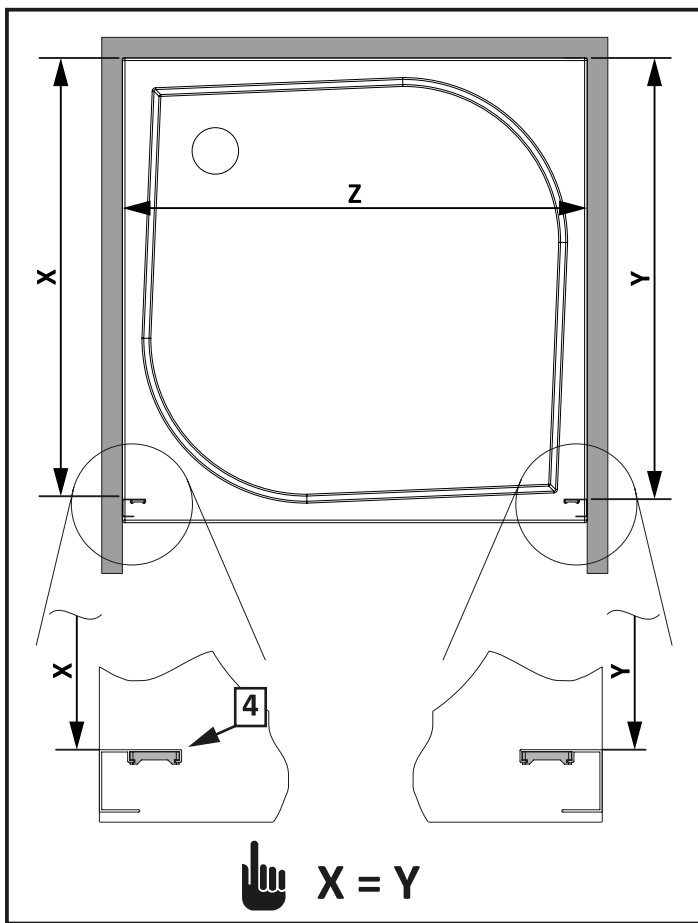
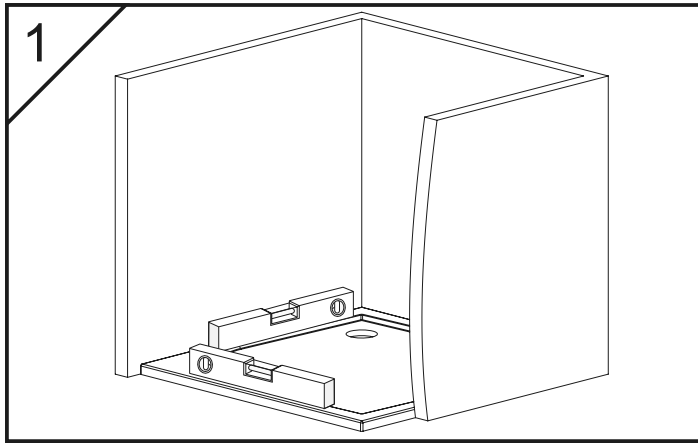

L	Z
800	785-815
900	885-915
1000	985-1015
1100	1085-1115
1200	1185-1215

